

CUTSHEET

Front View

Side View

Top View

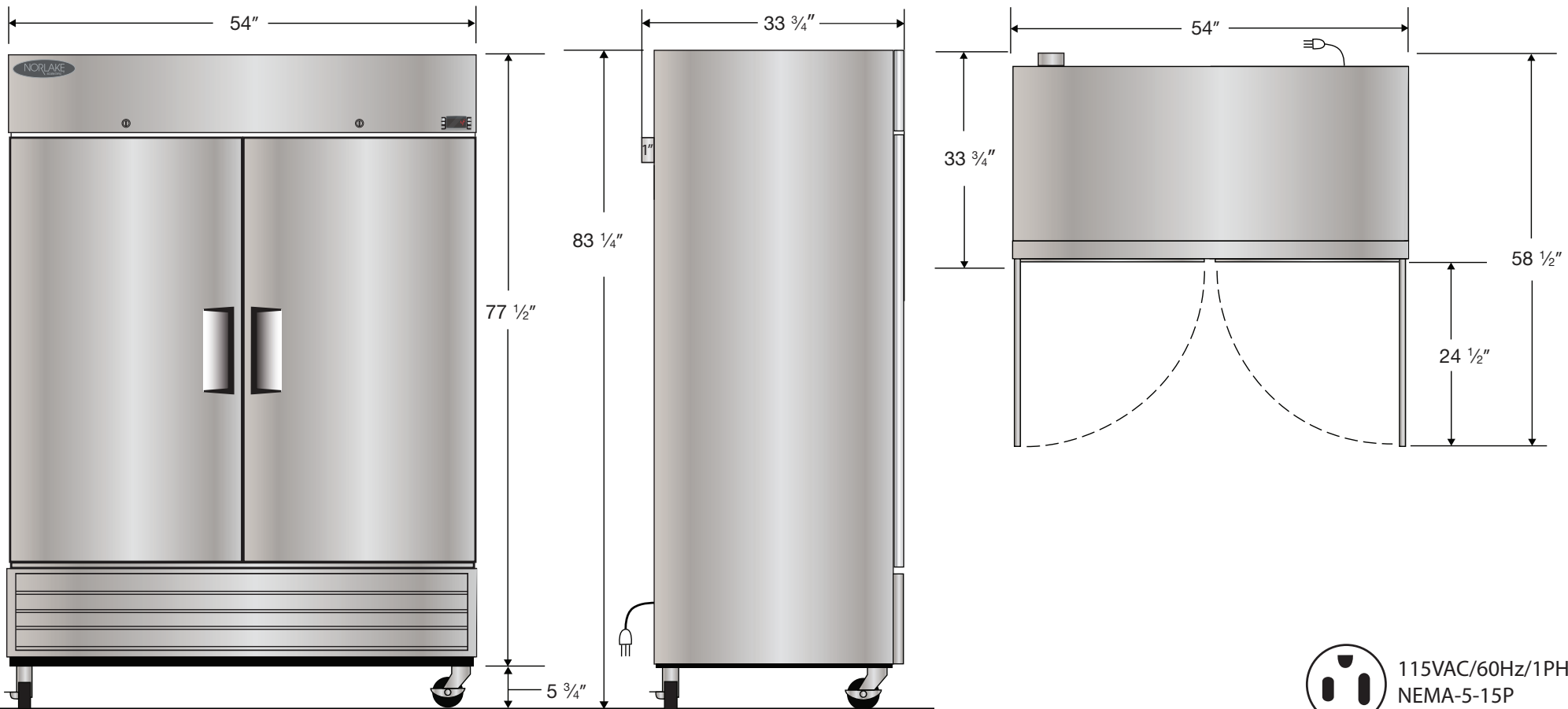

115VAC/60Hz/1PH  
NEMA-5-15P

Cu. Ft	Defrost	Door	Int Door	Shelves	W"	D"	H"	Refrigerant	H.P.	Amps	Weight
49	Cycle	2 Solid	0	6 Adj.	54	33 3/4	83 1/4	R290	1/4	4.5	435 lbs.